



Clean Fuel & Lubricant Solutions



Why Filter Fuels & Lubricants?

Today's sophisticated equipment, such as diesel engines with increased injection pressures, requires higher cleanliness levels than ever before. Donaldson bulk filtration systems save on costly component replacement, prevent unplanned downtime and prevent a decrease in fuel efficiency due to injector wear. In short, **Donaldson reduces your total cost of ownership.** Learn more about all things related to diesel fuel at MyCleanDiesel.com.





Table of Contents

- 3** Why Do I Need Clean Fuel?
- 4** What is Clean Fuel?
- 6** How Do I Get Clean Fuel?
- 8** Fuel and Lubricants Filters
- 10** System Sizing and Design
- 14** Flow Rates and Pressure Drops
- 16** Filter Heads
- 18** Manifolds
- 20** Clean Diesel Kits
- 21** Clean Diesel Carts
- 22** Bulk hP Filters and Heads
- 24** Flow Rates and Pressure Drops
- 26** T.R.A.P.™ Breather
- 28** Reservoir Air Dryer
- 30** Clean DEF Filter
- 32** Accessories



**DIESEL IS
DIRTY.**



**DIRT IS
BAD.**



**REMOVE THE DIRT.
ACHIEVE
MORE.**

As diesel travels from refinery to terminal locations to local bulk storage and finally to your bulk tank, it picks up contamination that is **deadly to today's engines.**

Your local distributor likely delivers diesel that meets or exceeds industry standards for fuel cleanliness. This is **not clean enough** for your equipment.

By filtering dirt, water and other contaminants before your fuel ever touches your equipment, you'll eliminate costly downtime, **Keep Running** and **Achieve More.**

GET A CLEAN SOLUTION.

To ensure that you're pumping clean, dry fuel into your equipment, call or email a Donaldson Clean Solutions expert. No matter where you are or the size of your operation, there's a Clean Solution that will help you **Achieve More.**





Achieving the Target Cleanliness of a Fluid

ISO 4406 contamination codes are a way to express fluid cleanliness. The three numbers correspond to the number of particles 4 microns and larger, 6 microns and larger, and 14 microns and larger present in the fluid. This page illustrates what it means to start with a contamination of ISO 22/21/18 and target a cleanliness of ISO 14/13/11.

ISO 4406 CONTAMINATION CODES

Range of number of particles per 100 milliliters

CODE	MORE THAN	UP TO & INCLUDING
24	8,000,000	16,000,000
23	4,000,000	8,000,000
22	2,000,000	4,000,000
21	1,000,000	2,000,000
20	500,000	1,000,000
19	250,000	500,000
18	130,000	250,000
17	64,000	130,000
16	32,000	64,000
15	16,000	32,000
14	8,000	16,000
13	4,000	8,000
12	2,000	4,000
11	1,000	2,000
10	500	1,000
9	250	500
8	130	250
7	64	130
6	32	64
5	16	32
4	8	16
3	4	8
2	2	4
1	1	2

RECOMMENDED ISO CLEANLINESS RATINGS

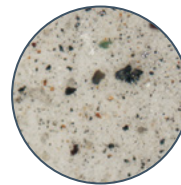

ISO 22/21/18
Typical cleanliness as fluid goes into your equipment



ISO 14/13/11
Target rating for diesel fuel



ISO 16/14/11
Target rating for hydraulic/transmission oils



ISO 18/16/13
Target rating for heavy gear/engine oils

ISO
22 / 21 / 18

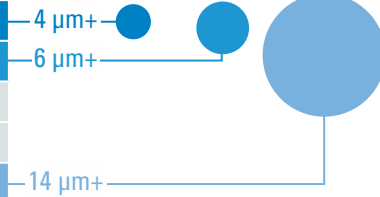

ISO
14 / 13 / 11

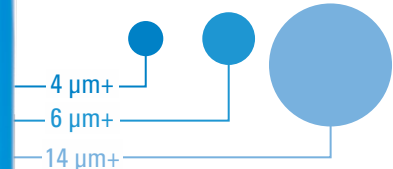



SIZES OF FAMILIAR PARTICLES IN MICRONS

100 µm	Grain of Table Salt
80 µm	Human Hair
40 µm	Lower Limit of Visibility
25 µm	White Blood Cell
10 µm	Talcum Powder
8 µm	Red Blood Cell
2 µm	Bacteria
<.5 µm	Silt

Donaldson Delivers Water Protection

Are your bulk fluids passing large amounts of free water downstream – contaminating vehicles and equipment?

Donaldson’s water absorbing filter with super absorbent polymer media, DBB0248, will stop flow if large amounts of free water are detected in your ethanol-free fluids. Designing systems with water absorbing filters requires careful sizing considerations. Use the System Sizing and Design section on pages 10 – 13 for information on how to properly configure a filtration system for your application. If further assistance is required contact a Donaldson specialist.



Choosing the Ideal Filters for Your System Doesn't Need to be Complicated

- 1 Select the **right filter** to achieve **targeted ISO cleanliness**. Proper design of the system will help avoid unnecessary costs.
- 2 Determine the **working pressure** of the system and select the filter line compatible with that pressure.
- 3 Different **types of fluids** have different properties. **Fluid viscosity** plays an important role in restricting the flow through filters. Select a filter that has compatible media-to-fluid properties and will maintain adequate flow and avoid excessive pressure drops. See pages 14 – 15 for filter flow rates and pressure drops.



Donaldson Delivers Superior Bulk Fluid Filtration

Lower Total Cost of Ownership
 Avoid Unplanned Downtime
 Maximize Fuel Efficiency
 Low Installation Costs
 Custom Designs

Modular Solutions
 Compact Installation
 Low Inventory Costs
 Easily Shipped
 Easily Serviced



Clean.

Donaldson single-pass filtration on the inlet removes contamination before it can enter your storage tank.

Compact and easy to replace, Donaldson filters are an important line of defense in maintaining fluid quality and can be configured for high flow rates while minimizing pressure drop.



Protect.

T.R.A.P.™ Breathers and Reservoir Air Dryers reduce the risk of moisture and contaminants entering a bulk storage tank so fluids are kept clean and dry. Used together, they'll help guard fluids from free water, airborne contamination and microbial growth for as long as they stay in storage.

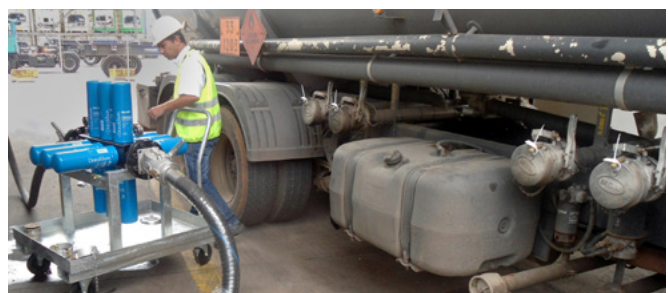

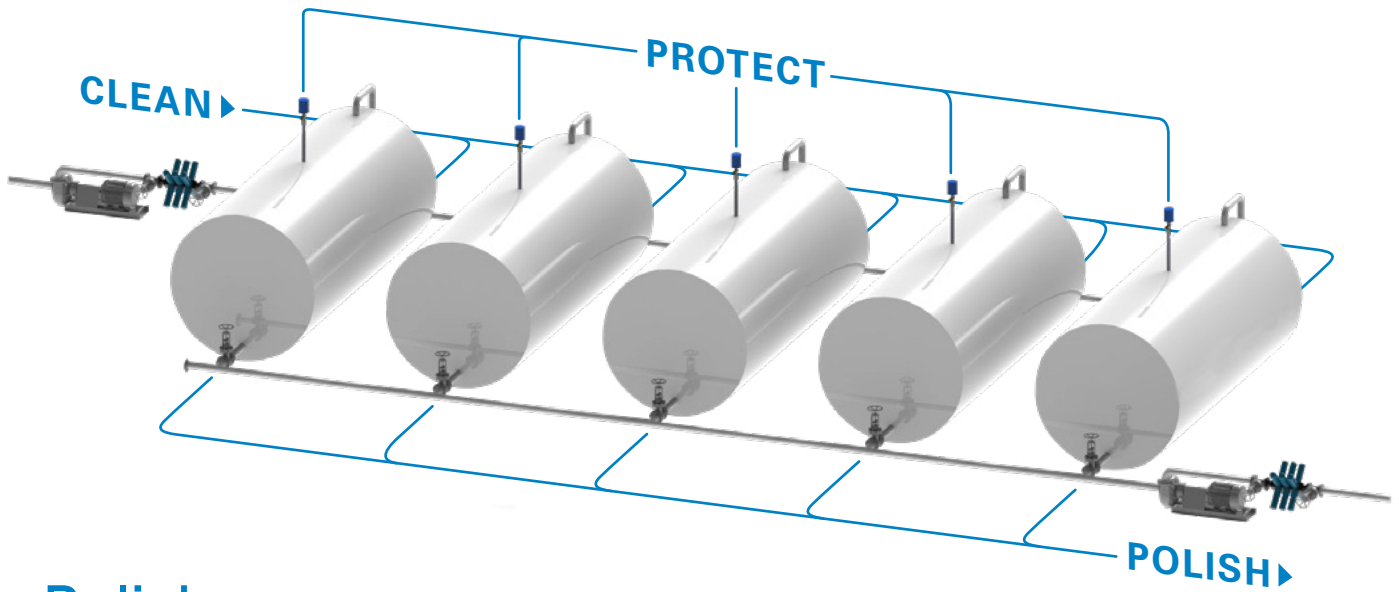

Polish.

Unstable fluids and the tank itself can be a source of contamination. Final filtration on the outlet with Donaldson filters ensures that targeted ISO cleanliness levels are achieved before fluids are pumped into your system.

Achieve More.





Fuel and Lubricants Filters

Premium Donaldson Blue® Clean Solutions filters provide unsurpassed cleanliness in a single pass. They are perfect for inlet and outlet filtration applications. Their spin-on design enables fast and simple filter changes without special tools and provides greater protection from contamination during service than traditional cartridge style filters.

Donaldson Blue bulk fluid filters incorporate our best technology and construction to handle all fuels and lubricants in all operating environments. Donaldson Electrostatic Reduction Technology (D.E.R.T.™) prevents filter media damage from electrostatic discharge. Epoxy is used in filter construction for increased fluid compatibility. E-coating provides maximum corrosion resistance and epoxy adhesion. fluorocarbon o-rings provide reliable sealing and maximum fluid compatibility.



FEATURES

- Highly efficient, state-of-the-art filter media and design
- Unsurpassed filter efficiency
- Cleans to target ISO cleanliness in a single pass
- Modular design can be configured for virtually any flow rate or usage level
- Fast and easy to service

APPLICATIONS

- Single pass filtration for clean fluid transfers
- High efficiency kidney looping
- Inlet and outlet filtration at bulk storage tanks
- Dispenser “polishing” filtration on fuel pumps and hose reels
- Mobile and stationary applications

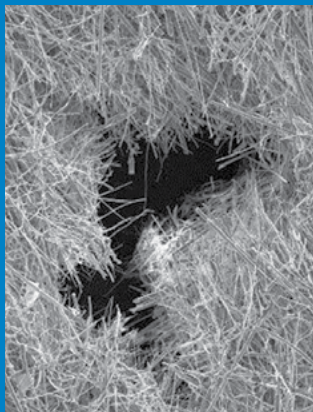

Filter media damage from Electrostatic Discharge (ESD).

D.E.R.T.™

Donaldson Electrostatic Reduction Technology

Electrostatic discharge can be created when diesel fuel or light oils pass through filter media at high flow rates.

The fluid being filtered may have inadequate conductivity to dissipate the charge generated by high flow filtration applications. The electrical charge can build-up in the fluid until it discharges or sparks across the filter, burning holes in the filter media and letting through harmful contaminants.

Donaldson’s proprietary Electrostatic Reduction Technology neutralizes electrical charge and prevents damage to the filter media. This enables efficient single pass fuel filtration in high flow applications.



Part Number	DBB5333	DBB7733	DBB8666	DBB8777	DBB8665	DBB2533	DBB8664	DBB0248	
Target ISO Cleanliness*	14/13/11 or better	16/14/11	14/13/11 or better	16/14/11		18/16/13		Not Applicable	
Efficiency	4 micron @ Beta 2000	7 micron @ Beta 2000	4 micron @ Beta 2000	7 micron @ Beta 2000		25 micron @ Beta 2000		Not for Particulate Removal	
Fluid Compatibility	All fuels				Transmission and hydraulic oil		Engine and gear oil		Ethanol-free fluids
Recommended Viscosity Range	< 100 cSt				< 500 cSt		< 3000 cSt		< 1500 cSt
Working Pressure	24.1 bar / 350 psi								
Element Collapse Pressure	10.3 bar / 150 psi								
Rated Static Burst	55.2 bar / 800 psi								
Max. Flow Range**	121 lpm / 32 gpm		246 lpm / 65 gpm			121 lpm / 32 gpm	246 lpm / 65 gpm		
D.E.R.T.***	Yes				No				
Nominal Dimensions	12.7 cm x 19.1 cm / 5 in x 7.5 in. 5.1 cm / 2 in. required for servicing		12.7 cm x 36.2 cm / 5 in x 14.25 in. 5.1 cm / 2 in. required for servicing			12.7 cm x 19.1 cm / 5 in x 7.5 in. 5.1 cm / 2 in. required for servicing	12.7 cm x 36.2 cm / 5 in x 14.25 in. 5.1 cm / 2 in. required for servicing		
Operating Temperature	-40 to 118°C / -40 to 245°F								

*Select the proper filter by fluid type and OE recommended ISO code. Do not over-filter fluids. Doing so may result in the stripping of beneficial additive.

**Actual flow rate varies based on fluid viscosity, pumping pressure and filter loading.

***D.E.R.T.™ Donaldson Electrostatic Reduction Technology prevents media damage during high flow fuel applications.

See pressure drop flow rate charts on pages 14–15.





Bulk filtration systems must be designed properly to meet the desired ISO cleanliness code while maintaining the existing flow rates. The filter type and quantity of filters varies based on the desired cleanliness, system pressure and flow rate.

Increasing the **flow rate** will increase the pressure drop across a filter. If the pressure drop is too high, system flow rate can be reduced or damage to the filter can occur. To reduce the pressure drop, increase the number of filters in the system.

The chart below demonstrates the **pressure drop** experienced by a filter with various viscosities and flow rates. The steeper the pressure drop curve, the more filters that must be added to the system.

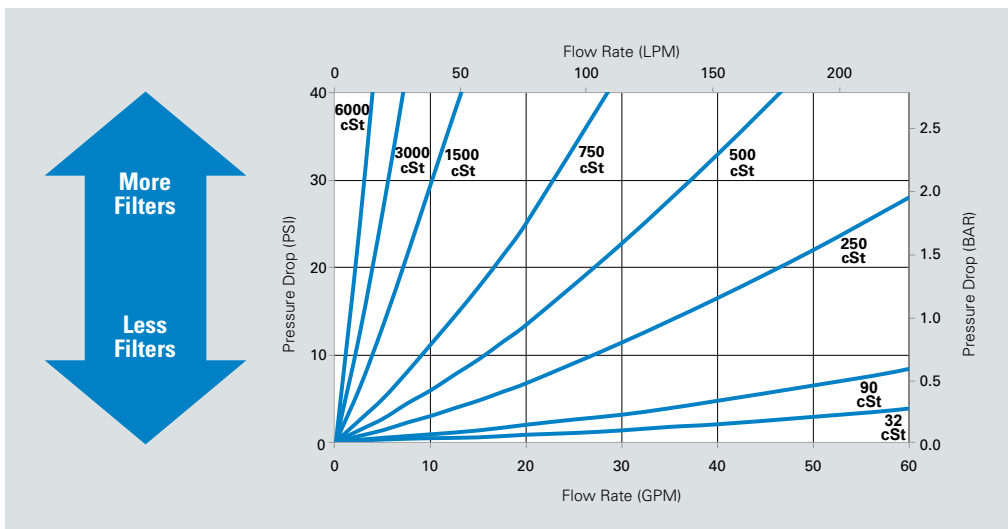
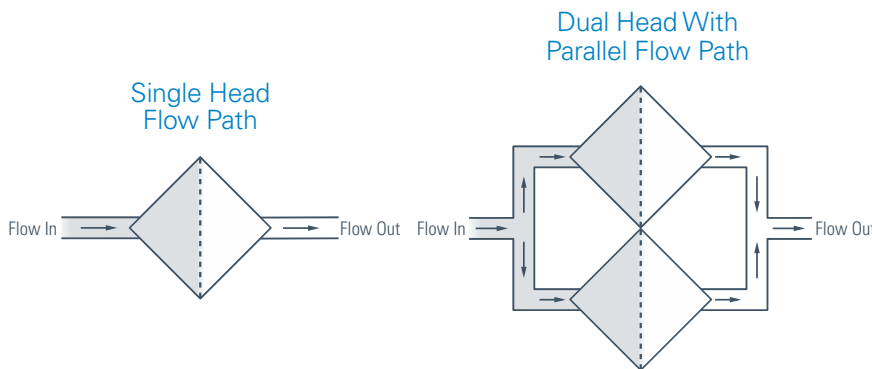

Additional filters plumbed in parallel will decrease the flow rate per filter, lowering the pressure drop and allowing existing flow rates to be maintained.



The Importance of Temperature in Sizing Your Filtration System

Fluid viscosity, measured in centistokes (cSt) or Saybolt Seconds Universal (SSU or SUS), is the resistance of a fluid to flow (thickness of fluid). Low viscosity fluids pass through filters with less resistance than high viscosity fluids. Higher fluid viscosities have higher pressure drops due to higher resistance passing through the media.

The colder the fluid, the higher the viscosity, so the lowest potential temperature of the fluid during filtration is the best measure for sizing a bulk filtration system. Due to the high specific heat capacity of fluids, the lowest ambient temperature may not be an accurate reflection of the actual fluid temperature. Avoid oversizing your system by using the stored fluid temperature and not the lowest ambient temperature, which tends to be lower than the temperature of the fluid in storage or transport.



WATER



HONEY

Temperature greatly impacts fluid viscosity. Consider that ISO 32 oil at 40°C / 104°F has the same viscosity as diesel fuel (similar to water). When temperatures drop to -20°C / -4°F, the viscosity of that ISO 32 oil increases dramatically to over 2,000 centistokes, which is similar to honey at room temperature.

FUEL / OIL KINEMATIC VISCOSITY COMBINED WITH TEMPERATURE IN CENTISTOKES CST

SAE Gear Oil			75W			80W	85W	90			140			
SAE Engine Oil			5W	10W		20		30	40	50				
ISO Grade			15	22	32	46	68	100	150	220	320	460	680	
°C	°F	Diesel												
120	248				4	4	6	7	9	12	13	18	23	
110	230				4	6	7	9	12	15	19	24	30	
100	212		1	5	5	7	9	11	15	19	25	32	41	
90	194		3	5	7	9	11	15	20	26	34	44	58	
80	176		5	7	9	11	15	20	27	36	48	63	85	
70	158		6	9	11	15	20	28	39	52	71	95	130	
60	140		8	12	15	21	29	40	57	80	110	151	211	
50	122		11	15	22	30	43	62	99	128	181	254	365	
40	104	1	15	22	32	46	68	100	150	220	320	460	680	
30	86	2	21	32	51	76	116	175	271	409	613	907	1,380	
20	68	3	33	51	87	135	214	334	536	838	1,290	1,980	3,130	
10	50	4	52	87	162	264	438	711	1,190	1,920	3,070	4,870	8,020	
0	32	5	85	180	340	585	1,020	1,720	2,990	5,060	8,400	13,900	23,900	
-10	14	9	185	375	820	1,500	2,770	4,880	8,890	15,700	27,200	47,000	85,000	
-20	-4	15	400	800	2,350	4,650	91,20	16,800	32,300	60,000				



Steps to Sizing a Bulk Application

1 Define product flow rate, fluid type and pressure drop restriction. New systems should ideally have less than 10 psi / .69 bar pressure drop for fuel and 15 psi / 1 bar pressure drop for lubricants.

2 Use the table on the page 11 to determine fluid viscosity using the fluid type and temperature.

INFORMATION GATHERING

FLOW RATE: _____

FLUID TYPE: _____

PRESSURE DROP: _____

TEMPERATURE: _____

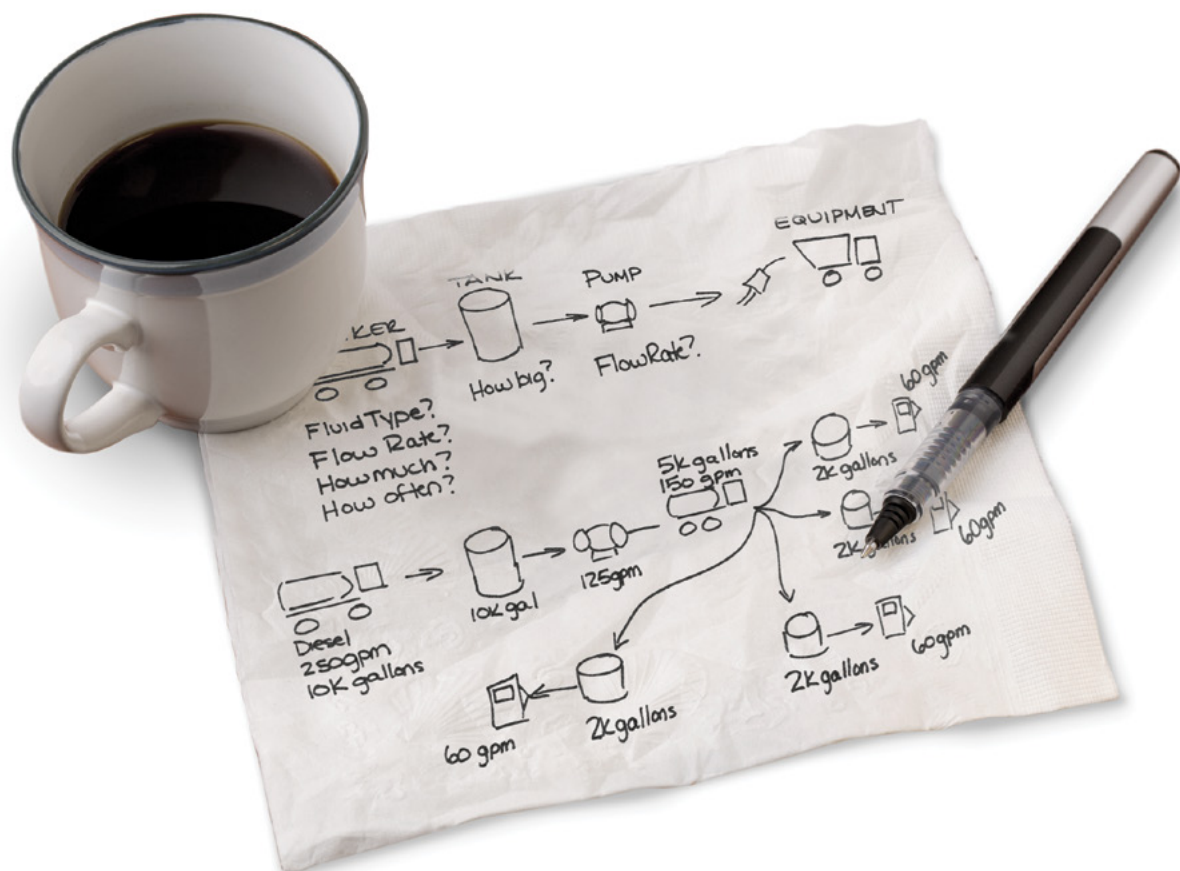



3 Select the appropriate filter based on desired ISO cleanliness code and working pressure (see pages 8 – 9).

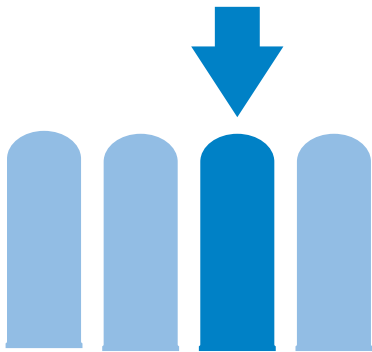

4 Determine the filter pressure drop using the flow rate and the fluid viscosity according to the appropriate chart on pages 11. Add the manifold pressure drop using the flow rate on pages 14 – 15 to calculate total pressure drop.

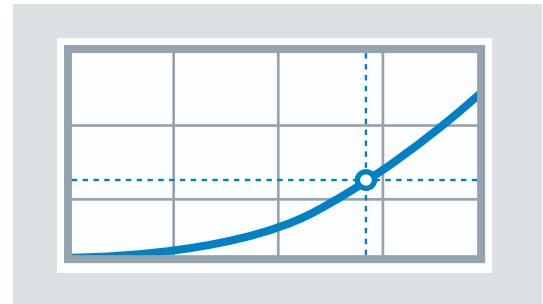

You Don't Need To Do It Alone.

Let a Donaldson specialist assist you by providing recommendations on sizing, selection and positioning of Donaldson filters. You can help us design your system by providing:

Responses to steps 1-4 above.

A schematic of your fluid transfer process (hand sketches work great), and/or

Photographs of your site (tanks, inlets and outlets).

Just call 800-374-1374 or visit MyCleanDiesel.com/Survey to get started.

Divide total pressure drop through one filter by the desired system pressure drop. This number is equal to the amount of filter required to clean the fluid properly at the determined flow rate. If the pressure drop is more than 10 psi / .69 bar pressure drop for fuel and 15 psi / 1 bar pressure drop for lubricants.

$$\frac{\text{CALCULATED PRESSURE DROP}}{\text{DESIRED PRESSURE DROP}} = \text{[Icon of two filter canisters]}$$



Flow Rates and Pressure Drops

FUEL FILTERS

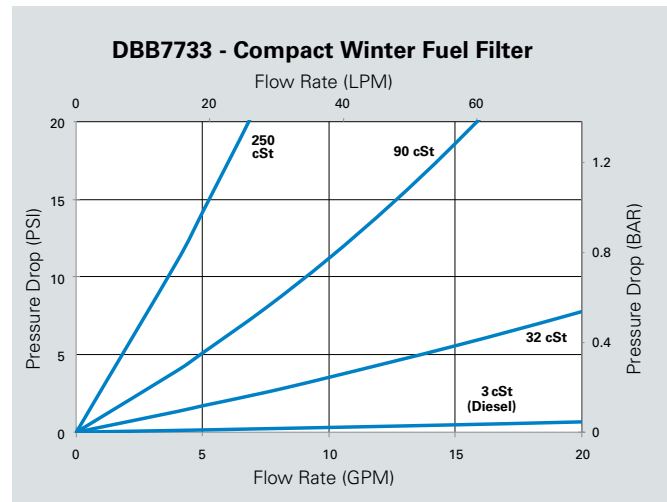
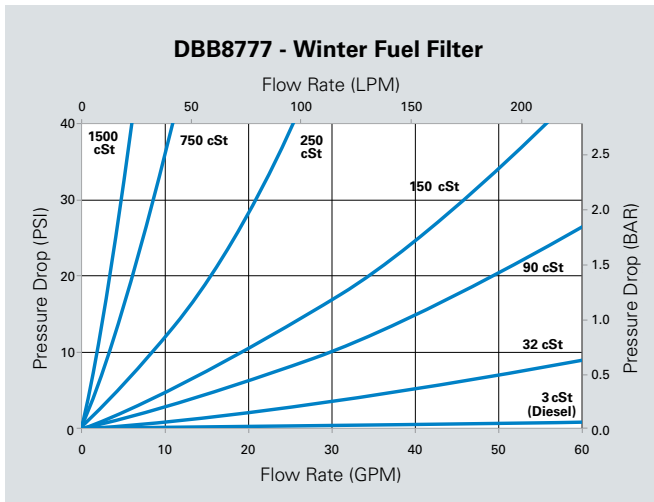
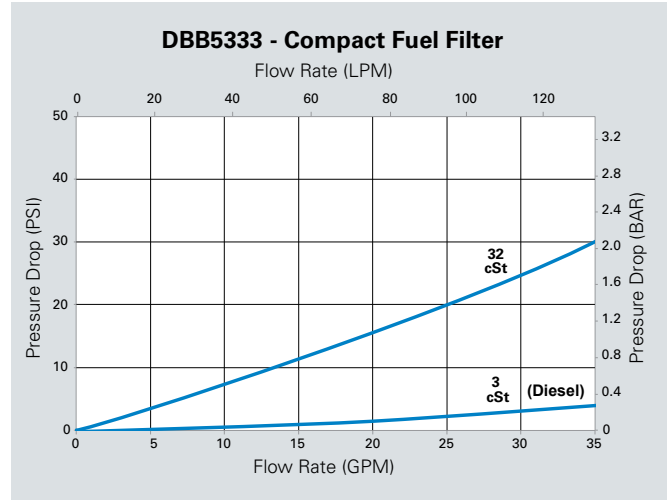
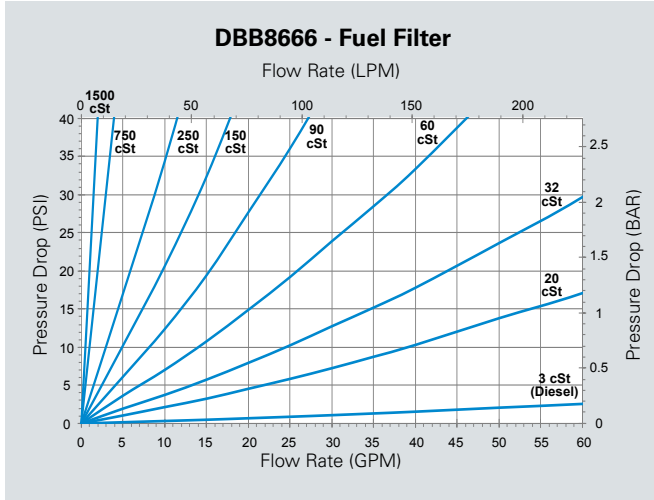



Flow Rates and Pressure Drops

LUBRICANT AND WATER ABSORBING FILTERS

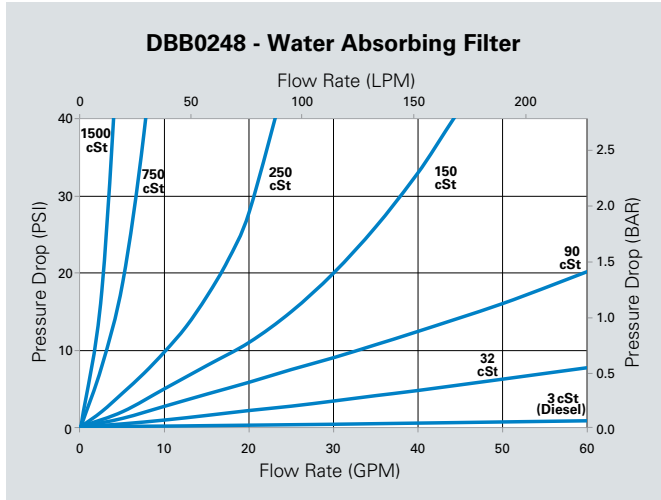
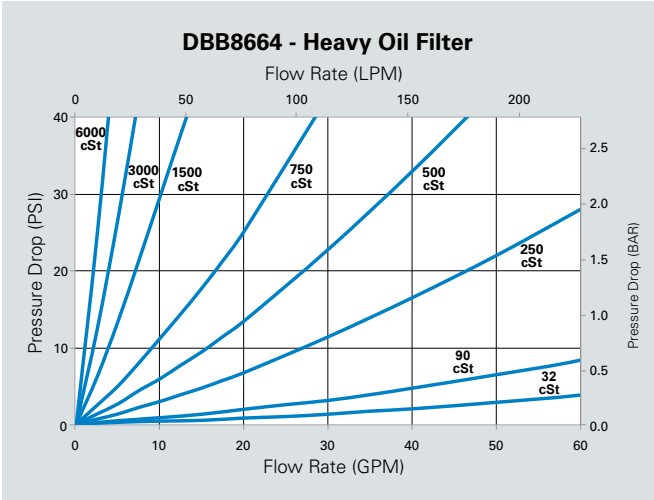
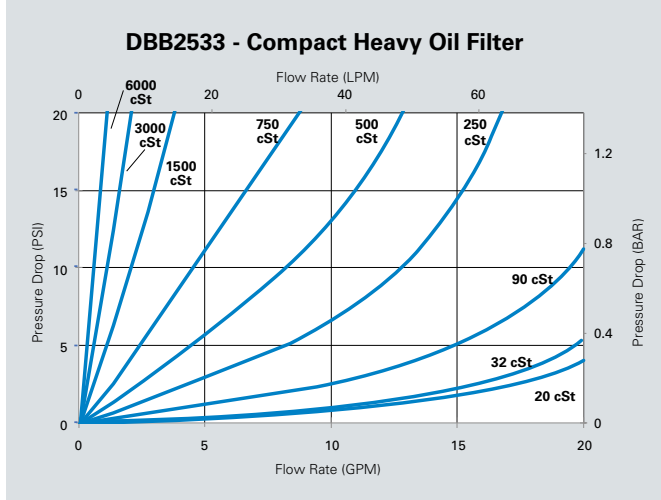
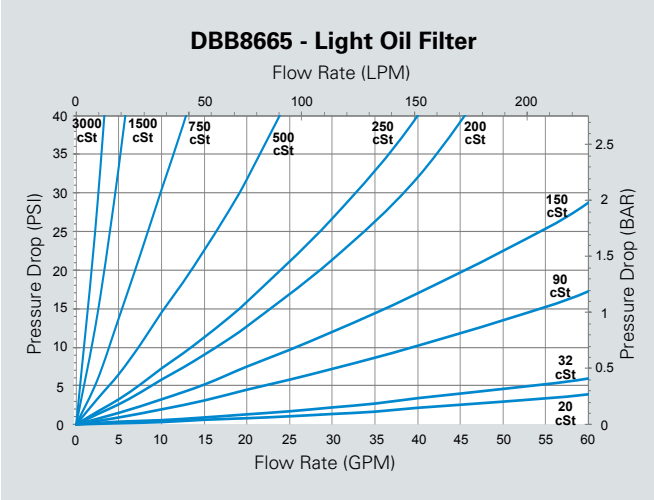

Filter Heads

Clean Solutions filter heads feature robust, aluminum construction with steel inserts to minimize metal-to-metal galling between the head and the filter, even when used with diesel fuel.

The threaded insert contains an O-ring seal to completely seal the clean side of the filter from the dirty side for maximum single pass protection. seals are compatible with a wide range of fluids and maintain their integrity in cold weather.

For maximum cleanliness, use Clean Solutions filter heads with Donaldson Blue bulk fluid filters.

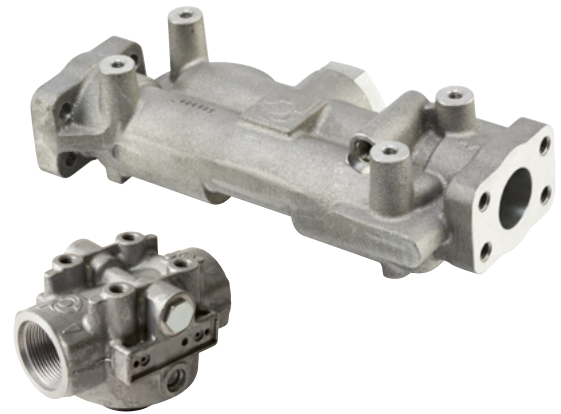

FEATURES

- Steel inserts are safe to use with all fuels
- Threads contain an O-ring to completely seal the clean side from the dirty side of the filter
- Heads are pre-ported for optional pressure gauges and service indicators

APPLICATIONS

- For use with Clean Solutions filters
- Compatible with all diesel fuels and lubricants



Single Filter Head



Single Filter Head 1 1/4 in. NPTF



Dual Filter Head



Part Number	P570329	P570330	P568583
Connection	SAE-20 O-ring	1 1/4 in. NPTF	1 1/2 in. SAE 4-Bolt Code 61 Flange
Filter Quantity*	1	1	2
Max. Flow Range**	246 lpm / 65 gpm		473 lpm / 125 gpm
Fluid Compatibility	All fuels and lubricants		
Working Pressure	24.1 bar / 350 psi		
Rated Static Burst	55.2 bar / 800 psi		
Operating Temperature	-40 to 118°C / -40 to 245°F		
Indicator Port	Use to adapt pressure gauges or sampling ports (sold separately see page 34).		
Materials	Aluminum head with threaded steel inserts and fluorocarbon seals		
Compatible Filters	DBB5333, DBB7733, DBB8666, DBB8777, DBB8665, DBB2533, DBB8664, DBB0248		

*Filters sold separately

**Actual flow rate varies based on fluid viscosity, pumping pressure and filter loading.



Single Filter Head
P570329 | P570330

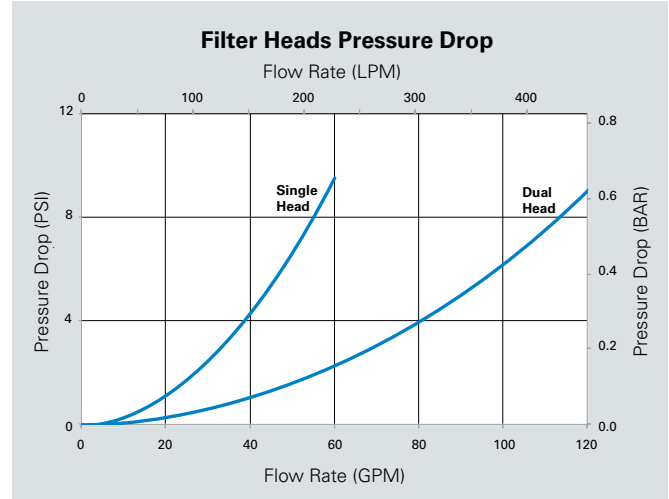
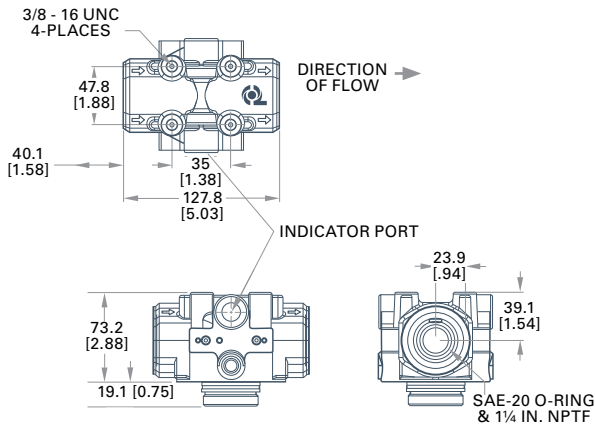

Dual Filter Head
P568583

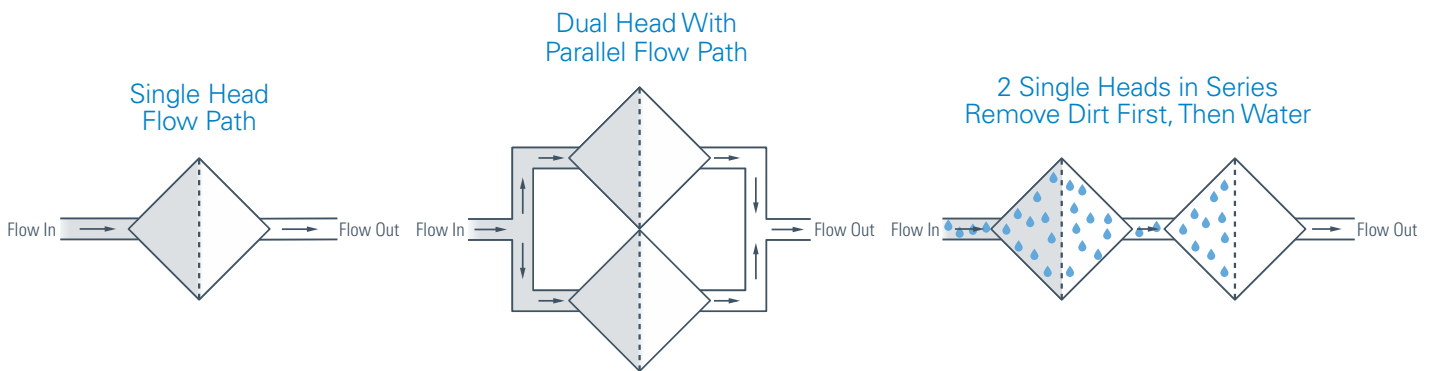
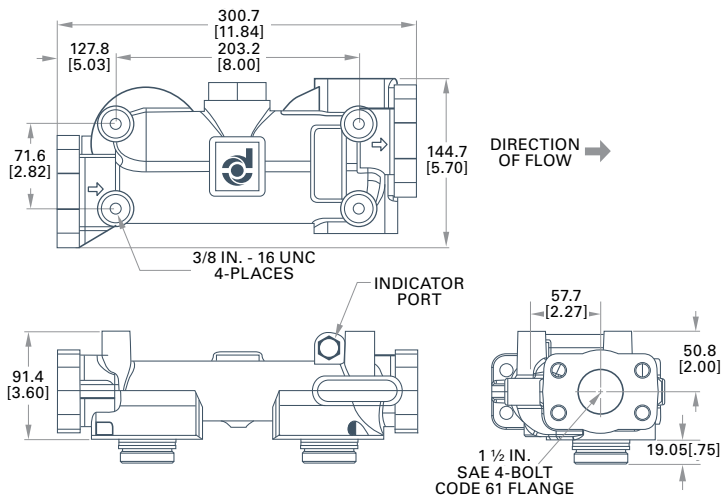

Manifolds

Clean Solutions Filter Manifolds extend service intervals or increase flow rate beyond the capability of a single or dual filter head. Two or more manifolds can be plumbed together to accommodate even larger flow rates.

Manifolds split flow evenly between the individual filters. Fluid passes through only one of the filters on its way across the manifold. Dividing the flow between multiple filters plumbed in parallel reduces the pressure drop through each filter.

The combination of Clean Solutions manifolds and filters ensure that your equipment receives the cleanest possible fuel and oil.



4 Filter Manifold





8 Filter Manifold



10 Filter Manifold



Inline 12 Filter Manifold

	Part Number	P561880	P568932	P568933	1KDFF1012
	Filter Quantity*	4	8	10	Up to 12
	Mounting Connection	2 in. ANSI 150 Flange	4 in. ANSI 150 Flange		
	Max. Flow Range**	946 lpm / 250 gpm	1893 lpm / 500 gpm	2271 lpm / 600 gpm	2650 lpm / 700 gpm
	Shipping Weight	64 kg / 140 lbs	141 kg / 310 lbs	177 kg / 390 lbs	58 kg / 128 lbs
	Pressure Gauges	2 pcs 0-11 bar / 0-160 psi gauges included			Accessories Sold Separately
	Sampling	Includes up-stream and down-stream mini-mess sampling ports with M16 x 2 thread			
	Fluid Compatibility	All fuels and lubricants			
	Working Pressure	ANSI B16.5 flange rating 20.0 bar / 290 psi up to 38°C / 100°F			10.3 bar / 150 psi
	Construction	Painted carbon steel pipe with aluminum heads			No external aluminum
	Compatible Filters	DBB5333, DBB7733, DBB8666, DBB8777, DBB8665, DBB2533, DBB8664, DBB0248			
	Operating Temperature	-40 to 118°C / -40 to 245°F			

*Filters sold separately

**Actual flow rate varies based on fluid viscosity, pumping pressure and filter loading.

FEATURES

- Fast, easy and safe to service
- Requires no electrical or air hook-ups
- Large capacity in small footprint
- Flexible mounting options (horizontal or vertical)
- Cost effective high capacity system

APPLICATIONS

- Bulk fuel and lubricant filtration and water removal
- High flow transfer into or out of tanks and dispensing equipment
- Hard-to-filter high viscosity oils
- Inline industrial filtration of gear oils and lubricants
- Kidney loop applications

 **4 Filter Manifold**
P561880

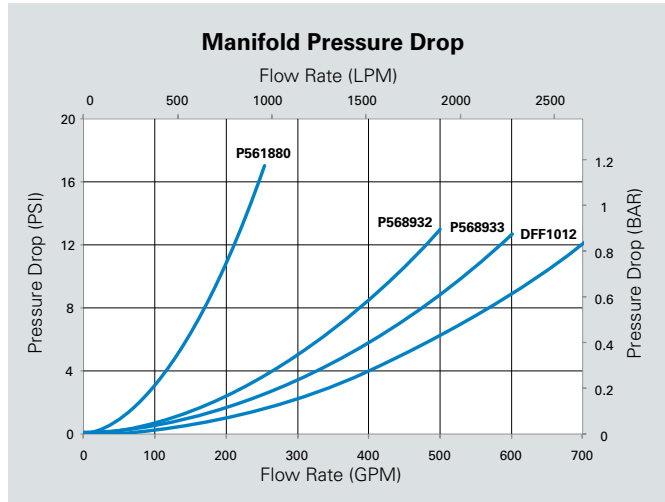
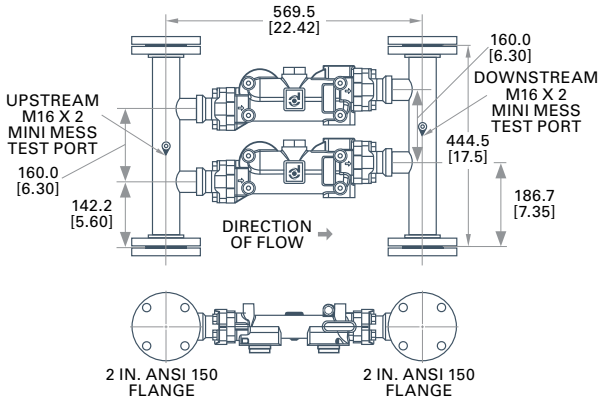

 **8 Filter Manifold**
P568932

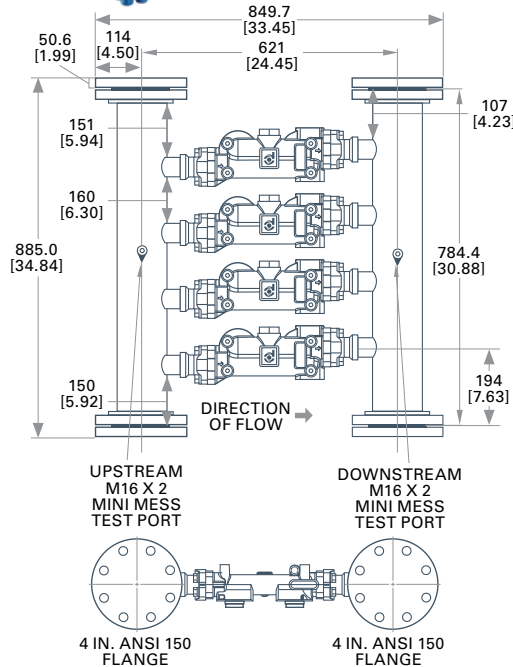

 **10 Filter Manifold**
P568933

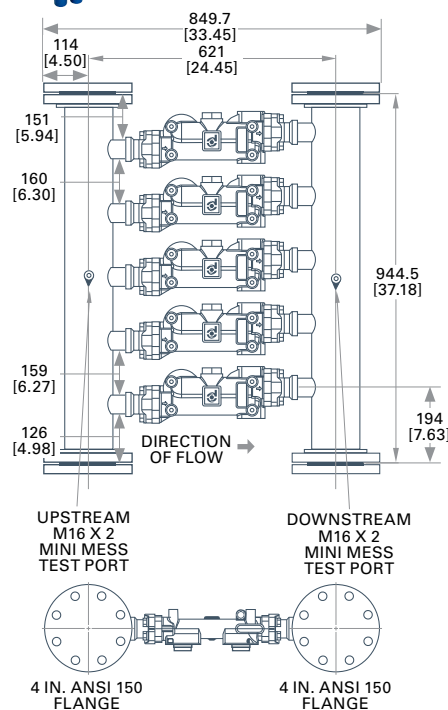

 **Inline 12 Manifold**
1KDF1012

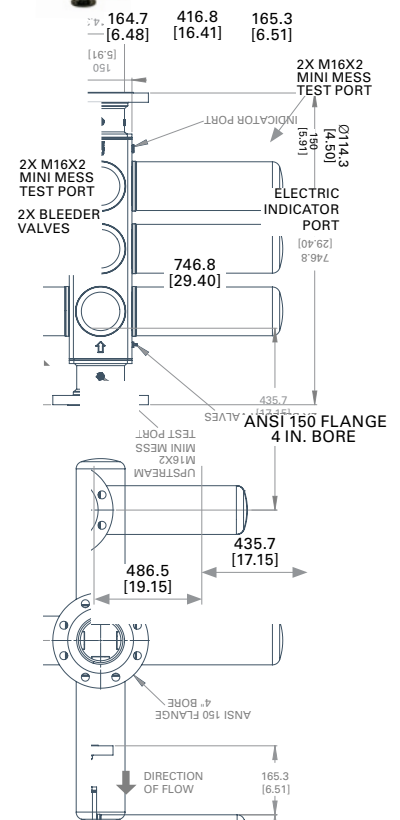

See page 34–35 for Blanking Caps and Other Accessories.



Clean Diesel Kits

Donaldson Clean Diesel Kits provide simple, effective outlet filtration on fuel dispensers to allow you to pump clean fuel into your vehicles and equipment.

These kits are easy to install on any fuel dispenser and come with everything needed to filter out even the finest contaminants before they can enter your equipment's fuel system. With the included easy-to-follow, step-by-step instructions, you'll have effective, efficient filtration in minutes.



COMPACT X011745

Parallel Filtration

For flow rates up to 121 LPM / 32 GPM

The Compact Clean Diesel Kit is designed for use on mobile service trucks, slip tanks, D-tanks, inside fuel dispensers and other tight locations.



HIGH-CAPACITY X011450

Parallel Filtration

For flow rates up to 473 LPM / 125 GPM

The High Capacity Clean Diesel Kit includes a dual head with two identical filters plumbed in parallel to accommodate higher flow rates and usage volumes.



STANDARD X011448

Parallel Filtration

For flow rates up to 246 LPM / 65 GPM

The Standard Clean Diesel Kit is perfect for smaller operations that need clean fuel delivered efficiently in any environment.



CLEAN AND DRY X011449

Series Filtration

For flow rates up to 189 LPM / 50 GPM

The Clean and Dry Diesel Kit removes fuel contamination, stops water and provides extra protection for your fuel in storage with the T.R.A.P.™ Breather.

See page 17 for Parallel and Series Filtration Flow Paths.



Clean Diesel Carts

Clean Diesel Carts are the perfect solution for fuel transfer and kidney loop applications. A high efficiency fuel filter and water absorber (included) work together to ensure that your diesel is both clean and dry.

The carts are powered by top quality pumps in your choice of AC 120V, DC 12V, or DC 24/12V. Maximum flow rates range from 56 lpm / 15 gpm to 80 lpm / 21 gpm, which makes short work of cleaning small to medium sized tanks. Easy to read, green to red service indicators on the two filters function independently, alerting the operator when one of the filters needs changing.



**AC
Clean Fuel Cart**



**12-Volt DC
Clean Fuel Cart**



**24-Volt DC
Clean Fuel Cart**

Part Number	X011407	X011408	X011431
Replacement Filter Elements	DBB8666 Fuel Filter & DBB0248 Water Absorbing Filter		
Target ISO Cleanliness	14/13/11 or better		
Fluid Compatibility	All diesel fuels and up to B20 bio-diesel blends		
Efficiency	4 micron @ Beta 2000		
Water Absorbing Filter	Stops all free and emulsified water		
Service Interval	25 psi service indicator moves from green to red		
Pump Model	Piusi® Panther 56	Piusi® Panther DC 12V	Piusi® Panther DC 24/12V
Power Consumption	700 Watts	420 Watts (35 amps @ 12V)	600 Watts (25 amps @ 24V) 192 Watts (16 amps @ 12V)
Working Pressure	1.6 bar / 23 psi	1.5 bar / 22 psi	
Relief	Internal bypass valve		
Max. Flow Range	56 lpm / 15 gpm	56 lpm / 15 gpm	70 lpm / 18 gpm @ 24V 35 lpm / 9 gpm @12V
Duty Cycle	Continuous	30 minutes	30 minutes



Bulk hP Filters and Heads

Filtering oil prior to dispensing into equipment is critical to meet the ISO cleanliness specifications demanded by today's OEM's. Donaldson Bulk hP filters provide high efficiency filtration in a single pass.

Service shops use high pressure pumps to force oil through long lengths of piping and hose reels prior to dispensing into equipment. Donaldson Bulk hP filters remove contaminants delivered in oil and picked up in storage or delivery lines during final transfer. They ensure the required ISO cleanliness level is met every time.



hP Single Head



hP Head with Bypass



Part Number	P566023	P566024
Working Pressure	68.9 bar / 1000 psi	
Indicator	Yes	
Bypass Valve	No	Yes 3.4 bar / 50 psi
Connections	SAE-16 O-ring	



Bulk hP Filter



Bulk hP Filter



Bulk hP Filter



Part Number	P565184	P565185	P565183
Target ISO Cleanliness	14/13/11	16/14/11	18/16/13
Fluid Compatibility	Petroleum Based Oils and Phosphate Ester Fluids		
Max. Flow Range	189 lpm / 50 gpm		
Efficiency	4 micron @ Beta 2000	8 micron @ Beta 2000	14 micron @ Beta 2000
Working Pressure	68.9 bar / 1000 psi		
Element Collapse Pressure	20.7 bar / 300 psi		
Application	Hydraulic, gear, transmission and engine oils		
Rated Static Burst	151.7 bar / 2200 psi		



FEATURES

- Up to 68.9 bar / 1000 psi working pressure
- Extended life filters with high dirt holding capacity
- Easy disposal with recyclable can and incinerable element
- Compact design requires only 38 mm / 1.5 in. clearance for servicing

APPLICATIONS

- Lube shops
- Mobile service trucks
- Other higher pressure single pass applications



Bulk hP Filter Heads
P566023 | P566024

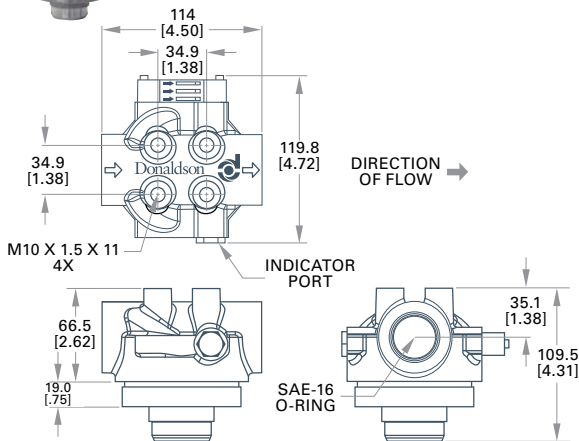

Bulk hP Filters
P565184 | P565185 | P565183

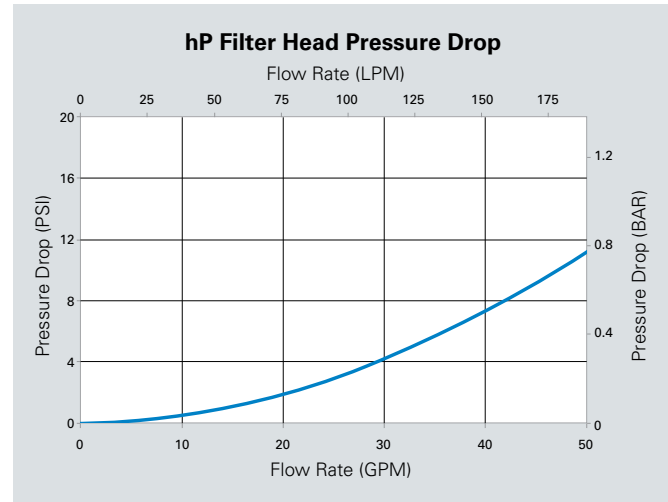
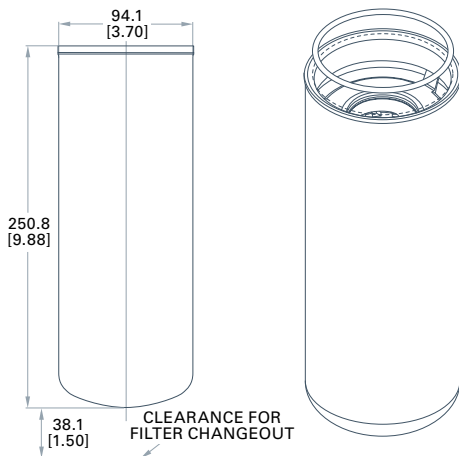

See System Sizing and Design on page 10 and pressure drop / flow rate curves on page 25.

WARNING

THERMAL EXPANSION Donaldson highly advises following the pump manufacturer's relief recommendations. Pump manufacturers offer relief valves to protect against over pressurization. A mere 5.5°C / 10°F increase in oil temp can add 31 bar / 450 psi to the system while the pump is shut off.



Fuel/Oil Kinematic Viscosity

COMBINED WITH TEMPERATURE IN CENTISTOKES CST

SAE Gear Oil			75W			80W	85W	90			140		
SAE Engine Oil		5W	10W		20		30	40	50				
ISO Grade		15	22	32	46	68	100	150	220	320	460	680	
°C	°F	Diesel											
120	248				4	4	6	7	9	12	13	18	23
110	230				4	6	7	9	12	15	19	24	30
100	212		1	5	5	7	9	11	15	19	25	32	41
90	194		3	5	7	9	11	15	20	26	34	44	58
80	176		5	7	9	11	15	20	27	36	48	63	85
70	158		6	9	11	15	20	28	39	52	71	95	130
60	140		8	12	15	21	29	40	57	80	110	151	211
50	122		11	15	22	30	43	62	99	128	181	254	365
40	104	1	15	22	32	46	68	100	150	220	320	460	680
30	86	2	21	32	51	76	116	175	271	409	613	907	1,380
20	68	3	33	51	87	135	214	334	536	838	1,290	1,980	3,130
10	50	4	52	87	162	264	438	711	1,190	1,920	3,070	4,870	8,020
0	32	5	85	180	340	585	1,020	1,720	2,990	5,060	8,400	13,900	23,900
-10	14	9	185	375	820	1,500	2,770	4,880	8,890	15,700	27,200	47,000	85,000
-20	-4	15	400	800	2,350	4,650	91,20	16,800	32,300	60,000			



Flow Rates and Pressure Drops

LUBRICANT FILTERS

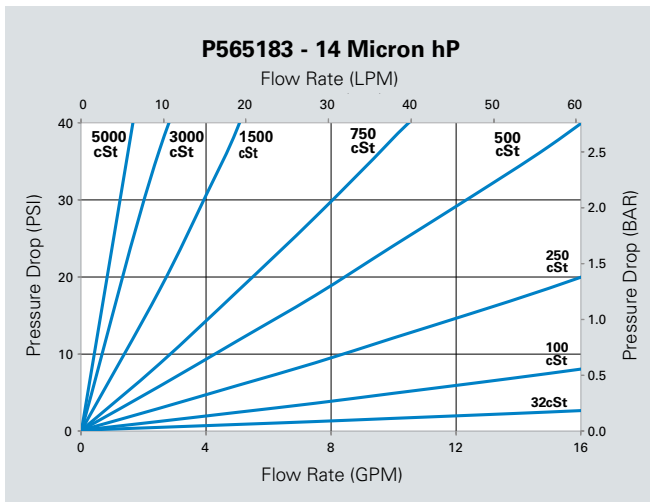
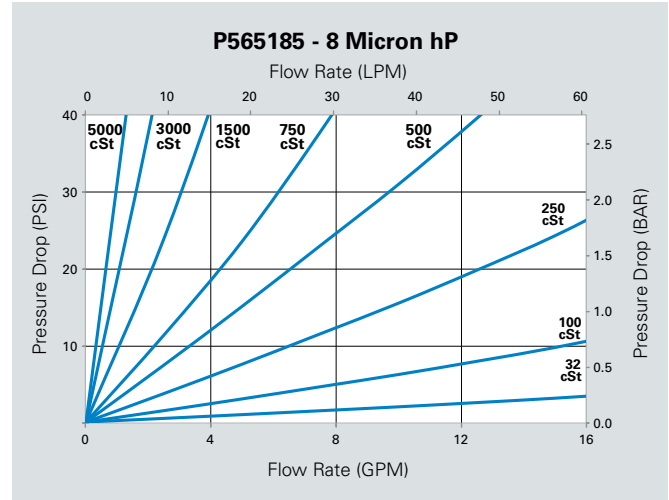
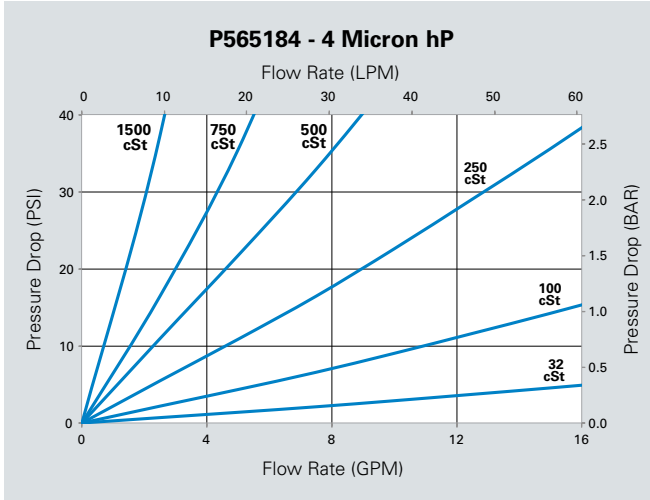



T.R.A.P.™ Breather

The Thermally Reactive Advanced Protection (T.R.A.P.™) Breather assembly protects the fluids in your storage tank from airborne particulate moisture contamination and ambient moisture.

It combines a high capacity 3 micron air filter with a deliquescent breather that dries itself when air is expelled from the tank. This self-regenerating capability of T.R.A.P.™ enables extended life and functionality.

Keep your fluids clean and dry with a Donaldson T.R.A.P.™ Breather.



Tanks sizes above 37,854 L / 10,000 gal may require multiple units and pressure vacuum relief valves.

Contact Donaldson for assistance.

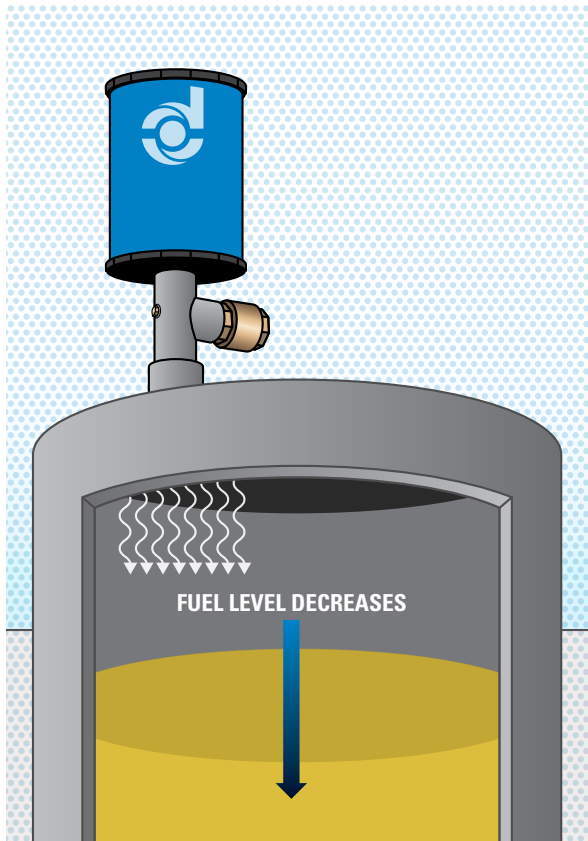

Assembly Part Number	X920006	
Efficiency	97% efficient @ 3 microns	
Max. Flow Range	Combined inlet and outlet flow up to 1500 lpm / 400 gpm maximum	
Overflow Check Valve	Opens at 10 mbar / 4 in. H ₂ O	
Operating Temperature	-40 to 93°C / -40 to 200°F	
Fluid Compatibility	Safe for use with all fuels and lubricants	
Indicator	Standard mechanical	
Construction	ABS housing, Urethane end caps	
Connection	1 ½ in. NPT female	
Replacement filter	P923075 spin on	
Ground Level Restriction Indicator*	X220074	
Restriction Gauge Kit* (Gauge & Fitting)		X002103
Restriction Limit	20" H ₂ O / 5 kPa	

*Indicators sold separately



FEATURES

- High efficiency air filtration
- Longer life and lower airflow restriction than typical silica gel breathers
- Self-regenerating moisture adsorption
- Easy to service

APPLICATIONS

- For use with all fuels and lubricants
- Above and below ground tanks
- Mobile service trucks
- Indoor or outdoor applications
- Most tanks up to 37,854 L / 10,000 gal (large tanks may require multiple units)

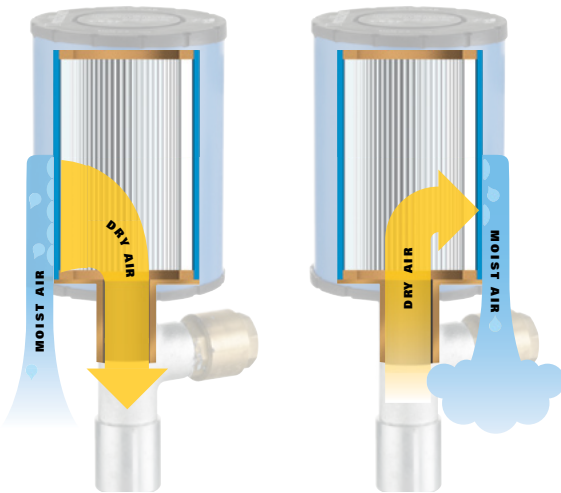
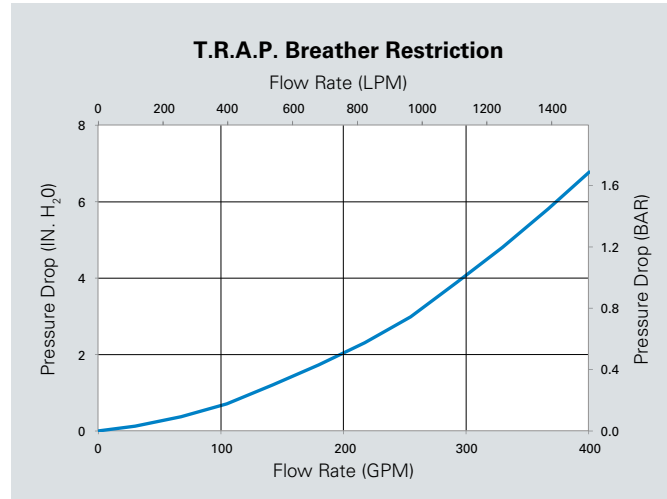

T.R.A.P.™ Breather
X920006

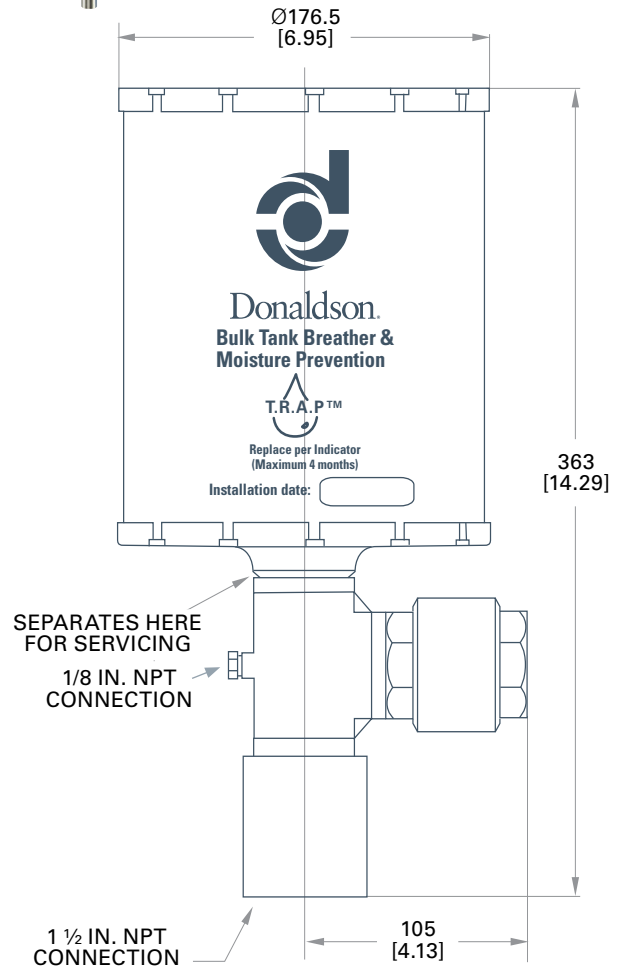

WARNING

Always locate your tank's name plate and cross check against the flow chart above to ensure safety. Use maximum flow INTO tank for validating pressure rating and flow OUT OF tank for vacuum ratings. **DO NOT EXCEED TANK PRESSURE OR VACUUM.**



Reservoir Air Dryer

The Donaldson Reservoir Air Dryer eliminates the need to continually replace conventional desiccant breathers, enhancing reservoir breathing systems by continuously purging and dehydrating reservoir head space.

With no electrical requirements, the Donaldson Reservoir Air Dryer combats ambient ingress of moisture by introducing a steady stream of clean, dry air to the reservoir. This constant airflow helps sustain optimal conditions and prevents the formation of condensation and rust in the reservoir, minimizing the potential for particulate and water ingress through reservoir access points.

When combined with a T.R.A.P.™ Breather, the complete system keeps moisture and contamination out, even if fluid flow rate out of the tank surpasses the Reservoir Air Dryer flow rate into the tank.

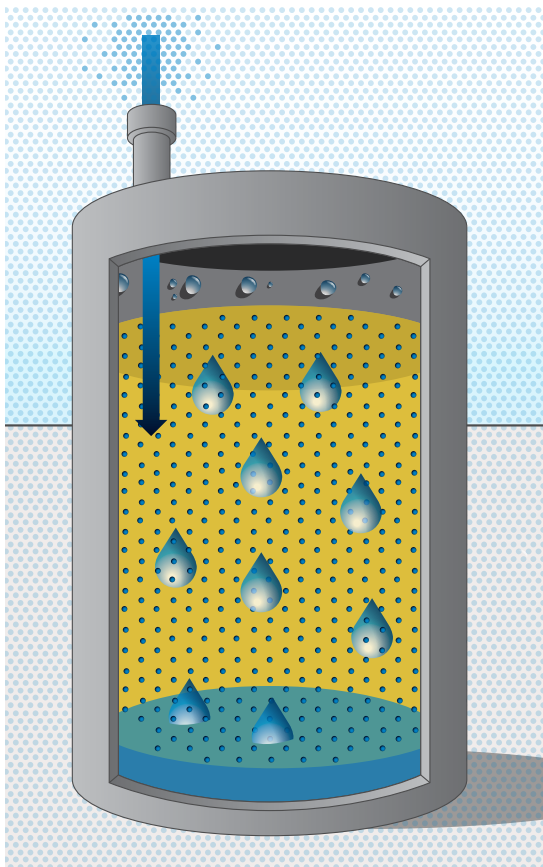

Reservoir Air Dryer

Assembly Part Number	P575852
Efficiency	Reduces dew point as much as 66°C / 150°F
Outlet Flow Volume @100 psi and dew point suppression	14.2 slpm / 0.5 scfm maximum
Inlet Air required @ 100 psi	22.7 slpm / 0.8 scfm maximum
Pre-Filter Condition	Visual Indicator (Green/Red)
Pressure Regulator	Dial Gauge
Coalescer Drain	Automatic Float Type
Max Working Pressure	8.00 bar / 116 psi
Max Operating Temperature	52°C / 125°F
Fluid Compatibility	Petroleum and Phosphate Ester Fluids, Diesel Fuels*
Inlet/Outlet Connection	¼ in. NPT
Mounting Bracket	3/8 in. - 16 UN Threaded Nut
Weight	<3 kgs / <5 lbs
Replacement	Coalescing Pre-Filter**

*The Reservoir Air Dryer is not recommended for use on gasoline holding tanks or for the head space of any flammable liquid (Flash Point of 38°C / 100°F)
**Supplied by IMI Norgren® as part number P925-09. Norgren is a registered trademark of IMI Precision Engineering

FEATURES

- The clean, dry air sweep dehydrates the reservoir head space and removes dissolved moisture from exposed oils and fuels*
- Operates with standard plant air; instrument quality air is not required.
- Sub-micron coalescing air filter collects oil and water droplets and fine particles from inlet air
- Automatic drain purges captured liquid with no intervention required
- Visual indicator monitors filter condition
- Membrane air dryer reduces plant air dew point by as much as 83°C / 150°F
- Pressure regulator de-pressurizes the air and ensures that the proper flow rate of air is introduced into the reservoir

APPLICATIONS

- Lubricant system reservoirs
- Diesel storage tanks
- Oil storage tanks
- Gear boxes
- Hydraulic reservoirs



**The Reservoir Air Dryer is not recommended for use on gasoline holding tanks or for the head space of any flammable liquid (Flash Point of 38°C / 100°F)*



Reservoir Air Vent
P575852

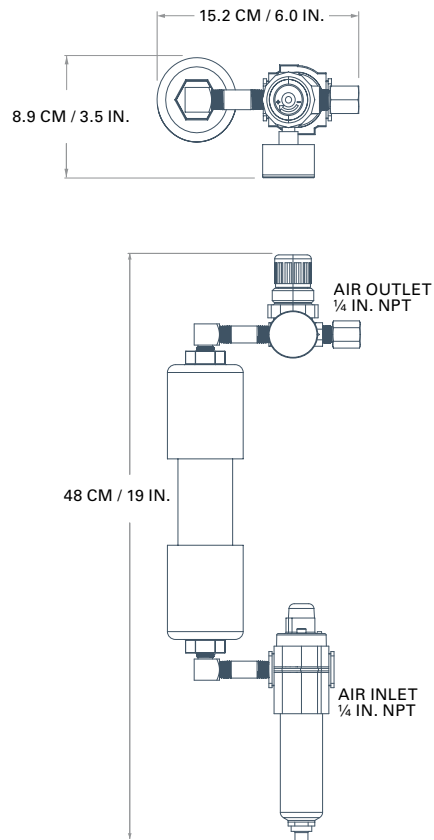



Clean DEF Filter

Today's Selective Catalytic Reduction (SCR) emissions control systems require clean Diesel Exhaust Fluid (DEF) for precise dosing and complete atomization to occur. However, contamination from transfer and storage or corrosion from incompatible materials can prevent your SCR system from getting the clean DEF it needs for proper operation.

The Donaldson DEF filter catches contaminants before they reach your vehicle or equipment and the onboard DEF filter. Clean DEF ensures proper function of the SCR and extends the life of the onboard DEF filter.

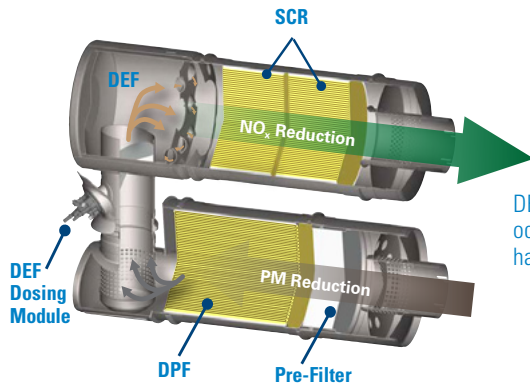

DEF must be clean for proper dosing to occur and turn NOx from exhaust into harmless nitrogen and water vapor.



DEF Filter Housing



DEF Filter



DEF O-ring

	Part Number	P575057 (1 in. NPT) Includes mounting bracket and filter wrench	P575059 Sold Separately	P575060 Replacement Part
	Efficiency	1 micron @ Beta 5000 (99.98%)		
	Max. Flow Range	38 lpm / 10 gpm		
	Working Pressure	20.7 bar / 300 psi		
	Operating Temperature	-11 to 50°C / 12 to 122°F		
	Housing Construction	316 stainless, EPR O-ring		
	Filter Material	Polypropylene, EPDM gaskets		
	Indicator Port	¼ in. NPT, upstream and downstream		
	Drain Plug	¼ in. NPT		



FEATURES

- 1 micron at beta 5000 efficiency
- 316 stainless steel housing
- Precise knife edge internal seal
- Heavy duty construction
- Maximum working pressure of 20.7 bar / 300 psi
- Leak-free O-ring seal
- Integrated gauge/sample ports
- Replacement filters available individually

APPLICATIONS

- DEF dispensers up to 38 lpm / 10 gpm

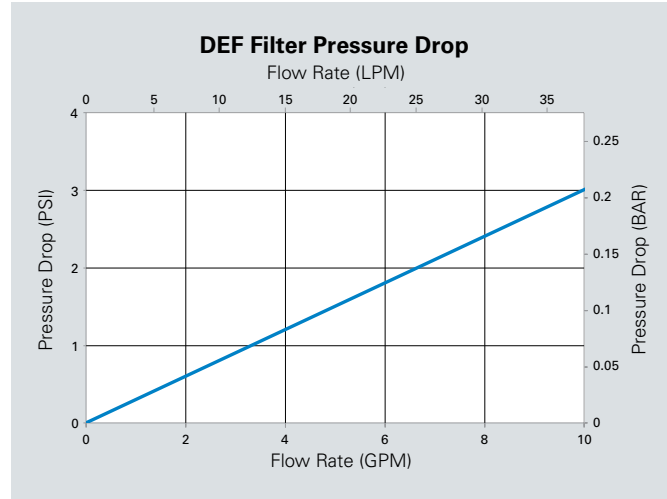

DEF Filter Housing
P575057

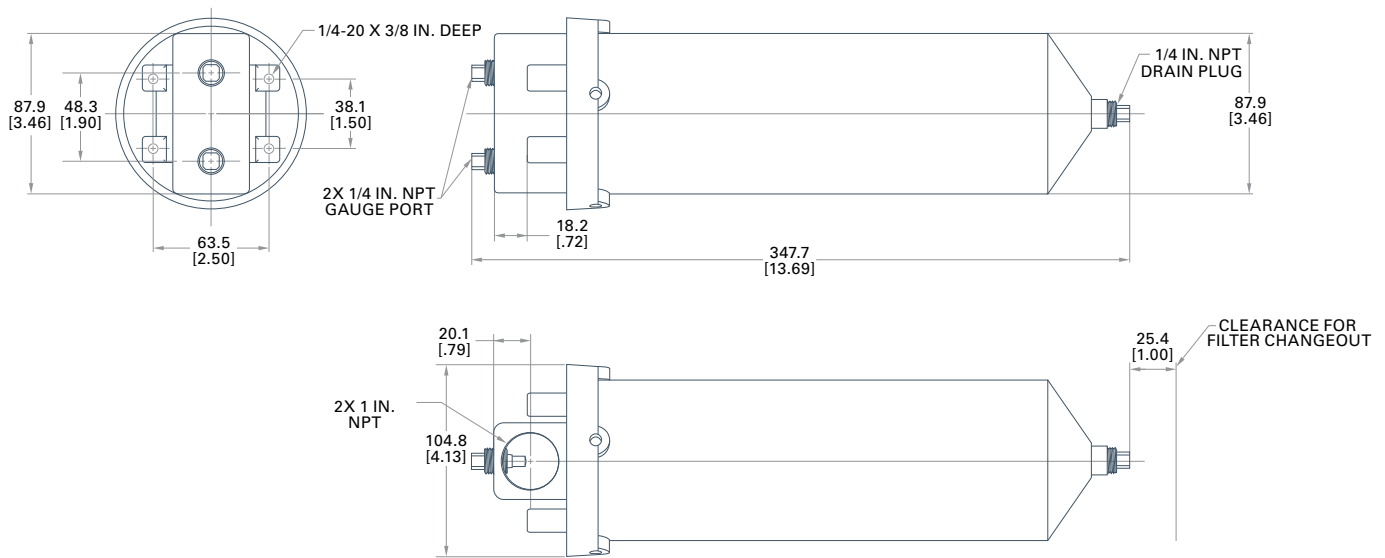

Stainless steel pressure gauge not included – must be sourced separately.

CAUTION

DEF IS HIGHLY CORROSIVE. All pipe fittings must be compatible with DEF. Most plastics as well as stainless steel are acceptable. Carbon steel, zinc, aluminum, brass, copper, etc. are not recommended due to undesirable chemical reactions. If any of these materials are used in your system they should be immediately replaced with a compatible material.

Accessories

Clean Solutions offers service indicators, patch test kit and other accessories that complement Donaldson bulk fluid filtration products. Accessory options allow you to meet specific installation and operation requirements.





We offer everything you need to ensure that your systems continue to operate at their peak performance levels.



PRESSURE GAUGES AND SERVICE INDICATORS

Part Number	Image	Description	Application
P173944		3-Wire Electrical Service Indicator 1.38 bar / 20 psi open/closed	Use with all Clean Solutions heads and manifolds, microprocessor compatible
P165965		Visual Service Indicator 1.72 bar / 25 psi	For single heads and hP heads, industrial grade green to red
P573682		Upstream Pressure Gauge Adapter	For single and dual heads, 1/8 in. NPT
P573681		Pressure Gauge, 4.1 bar / 0-60 psi	For single and dual heads, 1/8 in. NPT, center back mount, 1 1/2 in. diameter, use with P573682 adapter
P579714		Pressure Gauge, 6.89 bar / 0-100 psi	For single and dual heads, 1/8 in. NPT, center back mount, 2 in. diameter, use with P573682 adapter
P563212		Mini Mess Sample Port	For all Clean Solutions heads and manifolds, 1/8 in. NPT to M16 x 2
P563809		Direct Gauge Adapter	For Clean Solutions manifolds, M16 x 2 to 1/4 in. NPT adapter, use to mount pressure gauge to test point
P562709		Pressure Gauge, 11.0 bar / 0-160 psi	For Clean Solutions manifolds, stem mount, 2 1/2 in. diameter, use with P563809 adapter
X220074		Ground Level Restriction Indicator Kit	For T.R.A.P.™ Breather assemblies, allows ground level monitoring

PARTS

Part Number	Image	Description	Application
DFF1005		I-12 Blanking Cap	Blank off up to 6 orifices on I-12 manifold for flush mounting
P563107		4-Bolt Code 61 Flange to 1 1/2 in. NPT Adapter	Adapts P568583 Dual Head to 1 1/2 in. NPT
P573642		Threaded Pipe Nipple	1 1/4 in. NPT, for connecting two P570330 single heads in series
P164050		Threaded Insert O-rings	Replacement o-rings for heads and manifolds. Not for use on hP heads
P564669		ABS Breather, 3 Micron	Small oil tanks under 1000 L / 250 gal, 1 in. NPT, splash containment for mobile applications

SAMPLING TOOLS

Part Number	Image	Description	Application
P573414		Upstream Sampling Port Adapter	For single, dual heads, and hP heads, SAE-4, use with P563224 for sampling
P573415		Downstream Indicator Port Adapter	For single, dual heads, and hP heads, SAE-4, use with P563224 for sampling
P577505		Upstream & Downstream Sampling Port Adapter	For single, dual heads, and hP heads, SAE-4, use with P563224 for sampling
P563224		Mini Mess Sample Port	For all Clean Solutions heads and manifolds, SAE-4 to M16 x 2, use with P573414 and P573415 adapters
P563250		Mini Mess Sample Port Hose Assembly, 12 in.	1620 series M16 x 2 thread, for use with P563212 and P563224 mini mess test points
P563252		Mini Mess Sample Port Hose Assembly, 24 in.	1620 series M16 x 2 thread, for use with P563212 and P563224 mini mess test points

PATCH TEST KIT

Fluid analysis is a snapshot of what is happening inside your equipment. It tells you the condition of the fuel or lubricant and identifies component wear and contamination in virtually any application. The Donaldson Patch Test Kit (**Part No. X009329**) allows you to conduct immediate on-site particulate analysis in as little as ten minutes.

Using the patch test method, you can quickly and reliably assign a three-digit cleanliness code per ISO 4406-1999 to a given fluid sample. Simply pull a 25 mL fluid sample through a patch membrane filter and compare oil sample particle distribution with the Fluid Cleanliness Comparison Guide (included) to assign an ISO Cleanliness Code.

- Use this kit to determine which systems need improved filtration
- When improvements are made, use it to monitor the cleanliness status of the system.
- A great alternative to expensive, portable electronic devices

Benefits

- Easy to use
- Results in as little as 10 minutes
- Measures particulate levels
- Provides reliable results

KIT CONTENTS

Kit Part Number X009329



Case Size: Height: 368.3 mm / 14.5 in. | Width: 489 mm / 19.25 in. | Depth: 197 mm / 7.75 in. | Case Weight: 4.51 kg / 9.95 lbs.

The **Donaldson Patch Test Kit** includes enough supplies for 200 fluid samples. All apparatus is securely packaged and well-protected with laser-etched foam in a sturdy carrying case.

Finding your Donaldson filter online has never been easier.

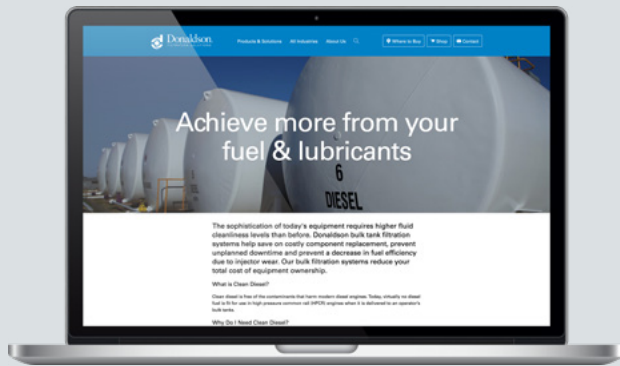

DIESEL.

Do you want to ensure you are pumping clean, dry fuel into your equipment? Check out **MyCleanDiesel.com** to find a Clean Solution offering that will help keep you running and *Achieve More*.

Need additional assistance? Fill out our survey for help from a Donaldson representative: **MyCleanDiesel.com/Survey**.



DISCOVER.

Looking for a complete filtration system or advice on choosing the right filter option? Go online to **donaldson.com** to learn about the broad range of filtration solutions offered by Donaldson – and to help you decide which option is right for your application.

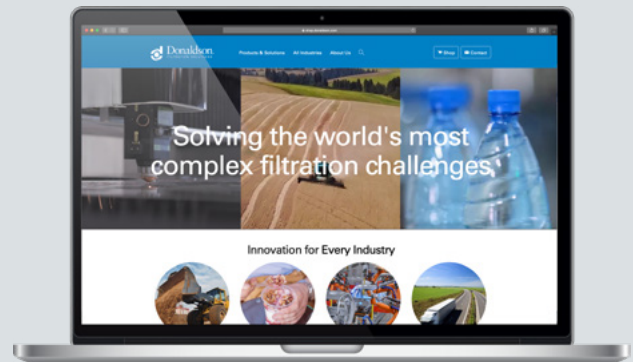

DECIDE.

If you're an equipment owner that needs to purchase filters and parts – it's easy to find the right Donaldson part, make an online shopping list and even request a quote from one of our distributors. We make finding filters *easier than easy* at **shop.donaldson.com**.

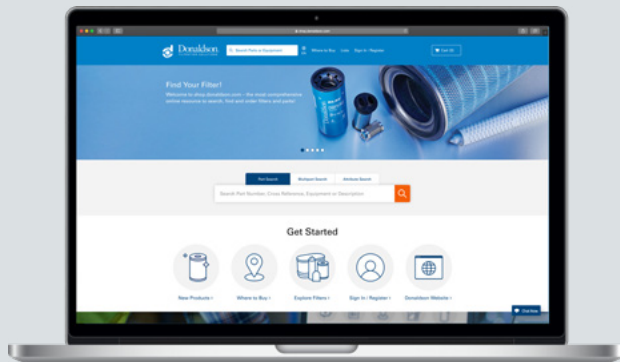



Global Presence with a Local Touch

At Donaldson, we've built a strong, flexible and responsive distribution network to serve our customers around the world.

Localized Manufacturing – It starts with 30+ manufacturing locations around the world – producing most filters in the regions where they're used.

Primary Distribution Centers – Filters then move to our regional warehouses and distribution center hubs – meaning the filters you need are never far away.

Logistics – We work with a network of transportation and logistics companies, consolidators and cross-docking facilities to deliver products to distribution partners quickly and efficiently.

Distribution Partners – We've built one of the largest, strongest and most responsive distributor networks in the filter industry – meaning you can find the filters and support you need, nearly anywhere in the world.



Donaldson Company, Inc.
Minneapolis, MN

North America 800-374-1374

MyCleanDiesel.com
donaldson.com
shop.donaldson.com

Need a Clean Solution?

As a global organization, we have offices throughout the world. Please direct your inquiry to clean.solutions@donaldson.com. This will enable us to address your inquiry in the shortest possible time.

Mexico
Latin America
Caribbean

Brazil
Europe & Middle East
South Africa

Southeast Asia
Greater China
Japan

Korea
Australia
India

Brochure No. F111500 ENG (10/2020)

© 2020 Donaldson Company, Inc. All rights reserved. Donaldson Company, Inc. reserves the right to change or discontinue any model or specification at any time and without notice. Printed in the U.S.A.